

# Manual

## PDB + SBEC Module

Voltage, Current, Capacity, Telemetry

No. S8474

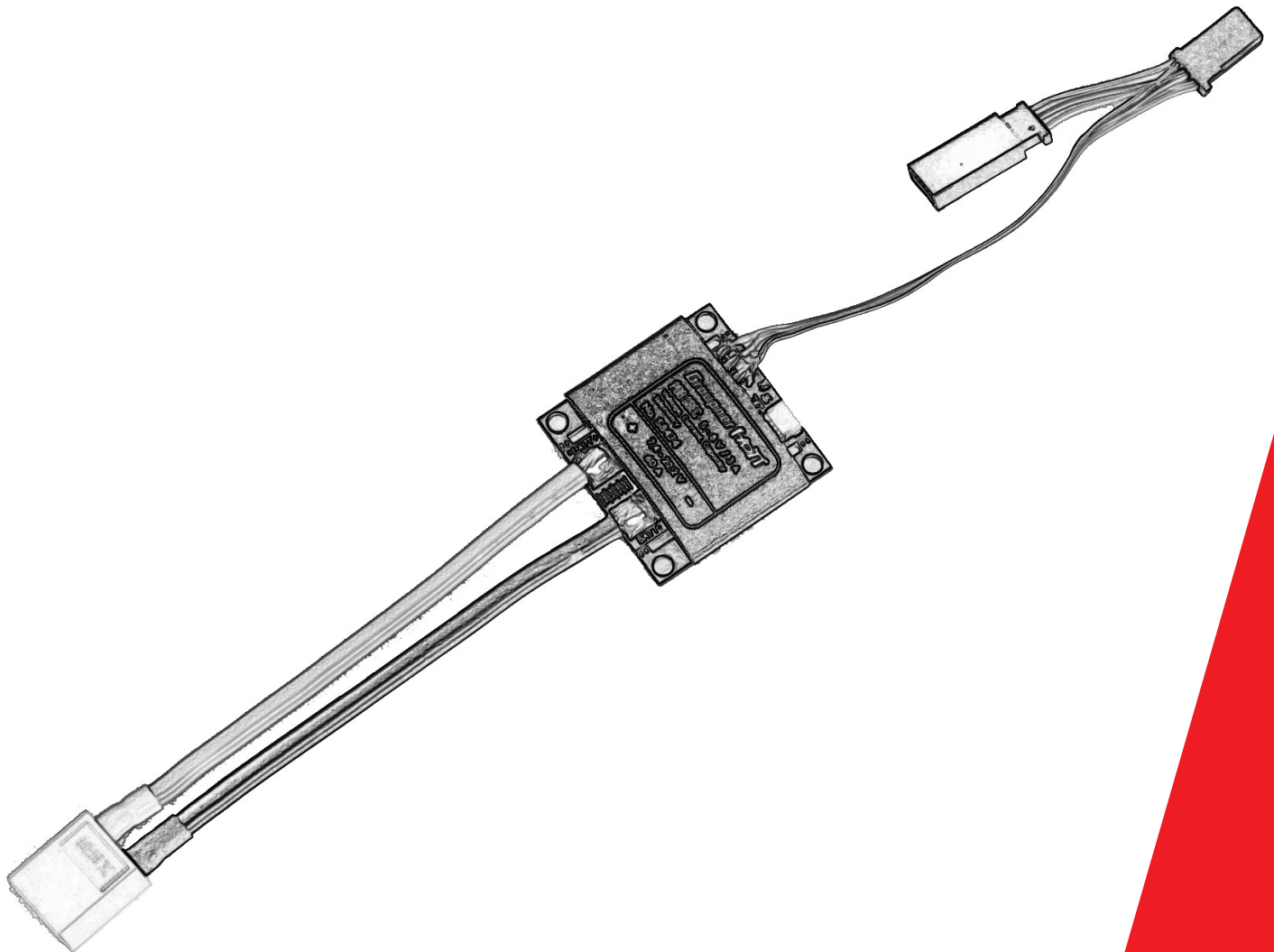

CE



---

## Index

Introduction .....	4
Service Centre .....	4
Intended use .....	5
Package content .....	5
Technical Data .....	5
Declaration of conformity .....	5
Symbols explication .....	6
Safety notes .....	6
Montage and connections .....	7
Programming the alarm threshold .....	7
Programming the User Setup .....	9
Ext. Switch .....	10
Indication in the transmitter telemetry display .....	10
Meaning of the red LED signals .....	10
Notes on environmental protection .....	11
Care and maintenance .....	11
Warranty certificate .....	11

---

## Introduction

Thank you very much for purchasing the **Graupner PDB + SBEC Module**.

This **PDB + SBEC Module** is extremely versatile.

Read this manual carefully to achieve the best results with your **PDB + SBEC Module** and first of all to safely control your models. If you experience any trouble during operation, take the instructions to help or ask your dealer or **Graupner** Service Centre.

Due to technical changes, the information may be changed in this manual without prior notice. Be always updated by checking periodically on our website, **[www.graupner.de](http://www.graupner.de)** to be always up to date with the products and firmwares.

This product complies with national and European legal requirements.

**To maintain this condition and to ensure safe operation, you must read and follow this user manual and the safety notes before using the product!**



### NOTICE

This manual is part of that product. It contains important information concerning operation and handling. Keep these instructions for future reference and give it to third person in case you gave the product.

---

## Service Centre

### Graupner Central Service

Graupner/SJ GmbH  
Henriettenstrasse 96  
D-73230 Kirchheim / Teck

Graupner USA  
OPENHHBBY LLC  
3245 University Ave  
Suite 1520  
San Diego, CA 92104

### Servicehotline

☎ (+49) (0)7021/722-130  
Monday - Thursday  
9:15 am - 4:00 pm  
Friday  
9:15 am - 1:00 pm

Website: [www.graupnerusa.com](http://www.graupnerusa.com)  
☎ (+1) 855-572-4746  
Email: [service@openhobby.com](mailto:service@openhobby.com)

### Graupner in Internet

For the service centers outside Germany please refer to our website **[www.graupner.de](http://www.graupner.de)**

---

## Intended use

The **PDB + SBEC Module** is used to easily monitor the LiXX battery through HoTT telemetry and as BEC power supply for receiver. The battery will be connected to the module through the battery connection cable. The battery is permanently monitored and through the programmable acoustic alarm the user can be informed in case the voltage is lower than the programmed threshold and about capacity and current consumption. Other uses are not allowed. For any improper use no warranty or liability is accepted.

Read through this entire manual before you attempt to install or use the **PDB + SBEC Module**.

**Graupner/SJ** constantly works on the development of all products; we reserve the right to change the item, its technology and equipment.

### Target group

The product is not a toy. It is not suitable for children under 14 years. The installation and operation of the **PDB + SBEC Module** must be performed by experienced modellers. If you do not have sufficient knowledge about dealing with radio-controlled models, please contact an experienced modeller or a model club.

---

## Package content

- ◆ **PDB + SBEC Module**
- ◆ Manual

---

## Technical Data

- ◆ Operational voltage - 7,4 to 22,2 V
- ◆ Max. current - 60 A
- ◆ BEC voltage - 4,5 to 8 V
- ◆ Dimensions - 35 x 35 x 7 mm
- ◆ Weight - 25 grams

---

## Declaration of conformity

### **S8474 PDB + SBEC**

Graupner/SJ declares that the product is conform to EU norms.  
EMC 2004/108/EC:

EN 61000-6-3: 2007+A1:2011

EN 61000-6-1:2007



---

## Symbols explication



Always observe the information indicated by this warning sign. Particularly those which are additionally marked with the words **CAUTION** or **WARNING**. The signal word **WARNING** indicates the potential for serious injury, the signal word **CAUTION** indicates possibility of lighter injuries.



The signal words **Note** and **Attention** indicate potential damages to objects.

---

## Safety notes



### General

These safety instructions are intended not only to protect the product, but also for your own and other people's safety. Therefore please read this section very carefully before using the product!

Do not carelessly leave the packaging material lying around, since it might become a dangerous toy for children.

- ◆ Persons, including children, with reduced physical, sensory or mental capabilities, or lack of experience or knowledge, or not capable to use safely the **PDB + SBEC Module** must not use the **PDB + SBEC Module** without supervision or instruction by a responsible person.
- ◆ The **PDB + SBEC Module** should never be in touch with water. Protect the module from dust, dirt, humidity and other small parts. Avoid abnormal mechanical stress. Risk of fire!
- ◆ Do not connect the **PDB + SBEC Module** with reversed polarity. Use polarity-safe plug-in systems. Avoid short-circuits. Risk of fire!
- ◆ Follow the safety instructions included with the batteries.
- ◆ Use the **PDB + SBEC Module** only within the indicated voltage range, risk of fire!
- ◆ The **PDB + SBEC Module** is conceived to be used only with Lithium batteries, the **PDB + SBEC Module** should not be used with other types of batteries, like NiMH or NiCd. Risk of fire!
- ◆ Changes and modification on the module are not allowed because of safety and conformity (CE) reasons
- ◆ For all questions that are not answered in this manual, please contact our Customer Service.

## Montage and connections

Install the **PDB + SBEC Module** in a proper place inside the model where it is protected from vibrations. Connect the 3 poles cable to the telemetry port of the receiver. The connectors are reverse polarity protected: note the small chamfers on the sides. Never use force – the connectors should engage easily. The socket is labeled accordingly:

Brown cable (-), red cable (+) and orange cable (T).

The battery cable with the XT-60 connector is connected to the battery. (Red = + / black = -)

The update port allows the receiver update even with connected module. To update the **PDB + SBEC Module** please read the instruction before you use the "Firmware\_upgrade\_studio" on [www.graupner.de](http://www.graupner.de). Moreover the BEC voltage can be used to power for example an FPV camera.

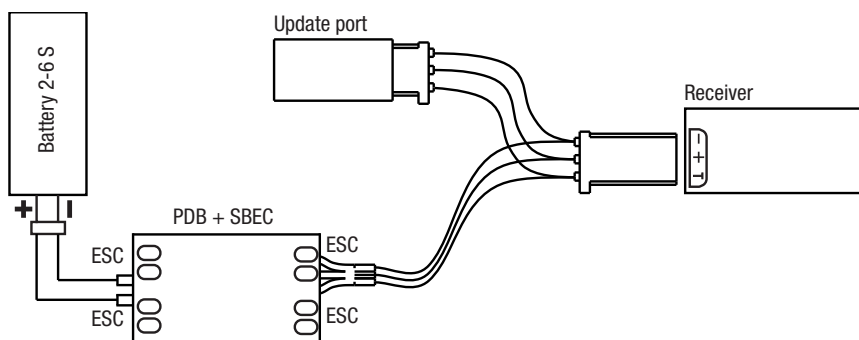

The small 3 poles socket is provided for switch functions. See paragraph "Programming the user setup"

## Programming the alarm threshold

The alarm thresholds are displayed in the telemetry menu of the transmitter. (Please read the manual of your transmitter how to view the telemetry menu and how to navigate it)

The first page of the **PDB + SBEC Module** in the telemetry menu is only a display page.

In the next pages the alarm thresholds can be set. It is possible to set up to 3 alarm thresholds for minimum battery voltage.

**Min Voltage:** The first alarm threshold can be used for the normal minimum voltage, e. g. to allow a safe return flight.

**Sensor 1:** The second alarm threshold can be set a little lower than the first one. So you can for example set a "coming home function".

**Sensor 2:** The third threshold is normally set a little lower e. g. to set a self landing function before the battery is completely empty.

```
VOLTAGE Sensor <>
> Voltage:      11,45V
  Min 11,42V Max 11,52V

BEC Voltage :   7,84V
Current:       0,8A
Max Current:   0,8A
Capacity:      0 mA
```

The following parameters can be set separately for all displays:

**Warning Time:** here you can set for each display if and how long the alarm should be active for a specific value.

**Repeat Time:** here you can set how often an alarm should be active when a specific value is reached.

**Signal Tone:** sets the signal tone melody. The warning sounds are combined with the warnings on the display and the voice output. Therefore, they may not be changed.

#### Page 1

```
VOLTAGE Sensor <>
>Set Warning : Page 1
Save Sensor? No
Factory Set No

Ver:P 1.000 6
```

#### Save Sensor: yes/no

After every setting in the pages "Page 1 - 5" the data must be transferred to the **PDB + SBEC Module**. Select "yes" and push "Enter". If you do not proceed as described, the new data will not be saved.

#### Factory set

A factory reset will be done if you select "yes" and push "Enter".

#### Page 2

```
Min. Power VOLTAGE
>Set Warning : Page2
Min Voltage : 11,0V
Warning Time: 10 sec
Repeat Time : 1 min
Signal Tone : P

Voltage : 11,41V
```

#### Min Power Voltage

Here you can set the alarm threshold for minimum voltage.

The alarm threshold can be set between 0 and 25.0 V in steps of 0,1 V.

Factory setting: 11.0 V, Signal Tone: P

#### Page 3

```
Sensor 1 VOLTAGE
>Set Warning : Page3
Min Voltage : 10,8V
Warning Time: 15 sec
Repeat Time : one
Signal Tone : R

Sensor 1 : 11,41V
```

#### Sensor 1 Voltage

Here you can set the first alarm threshold for voltage.

The alarm threshold can be set between 0 and 25.0 V in steps of 0,1 V.

Factory setting: 10.8 V, Signal Tone: R

#### Page 4

```
Sensor 2 VOLTAGE
>Set Warning : Page4
Min Voltage : 10,5V
Warning Time: Always
Repeat Time : Always
Signal Tone : S

Sensor 2 : 11,41V
```

#### Sensor 2 Voltage

Here you can set a second alarm threshold for voltage.

The alarm threshold can be set between 0 and 25.0 V in steps of 0,1 V.

Factory setting: 10.5 V, Signal Tone: S



## Page 5

```
Max. Power VOLTAGE
>Set Warning : Page5
Min Voltage : 17,5V
Warning Time: off
Repeat Time : Always
Signal Tone : X

Voltage : 11,41V
```

### Max Power Voltage

Here you can set the alarm threshold for maximum voltage.

The alarm threshold can be set between 0 and 25.0 V in steps of 0,1 V.

Factory setting: 17.5 V, Signal Tone: X

## Page 6

```
Max. Current
>Set Warning : Page6
Max Current : 40 A
Warning Time: off
Repeat Time : Always
Signal Tone : W

Current: 22A
```

### Max Current

Here you can set the first alarm threshold for maximum current.

The alarm threshold can be set between 0 and 150 A in steps of 1 A.

Factory setting: 40 A, Signal Tone: W

## Page 7

```
Max. Used Capacity
>Set Warning : Page7
Max Capacity: 2000mA
Warning Time: off
Repeat Time : Always
Signal Tone : U

Capacity: 0 mA
```

### Max used Capacity

Here you can set the alarm threshold for maximum consumed capacity.

The alarm threshold can be set between 0 and 30000 mA in steps of 10 mA.

Factory setting: 2000 mA, Signal Tone: V

---

## Programming the User Setup

### Page 1

```
VOLTAGE Sensor <
>User Setup : Page 1
Save Sensor? No
Factory Set No

6
```

In the "User Setup" the BEC voltage produced by the **PDB + SBEC Module** is set.

#### Save Sensor: yes/no

After every setting in the page "Page 2" the data must be transferred to the **PDB + SBEC Module**. Select "yes" and push "Enter". If you do not proceed as described, the new data will not be saved.

#### Factory set

A factory reset will be done if you select "yes" and push "Enter". All the values will be reset to the factory settings.

### Page 2

```
SBEC VOLTAGE
>User Setup : Page2
Set Voltage : 5,8V

BEC Voltage : 5,84V
```

### BEC Voltage

Here you set the BEC voltage.

The voltage can be set between 4,5 and 8 V.

In the following lines the BEC voltage will be shown.

## Ext. Switch

```

Ext. Switch
>User Setup: Page3
Control 1 : low
Control 2 : low
Control 3 : low
    
```

Here you can set the 3 switch outputs.

The value is settable between **high** and **low**.

**low** indicates that the output is switched off (0 V)

**high** indicates that the output is switched on (3 V)

Factory setting: **low**

Use example: to switch the video channel on the transmitter the switch outputs can be connected in parallel to the dip switch. Then **low** means status **ON** in the dip switch. In this case the dip switch must be set to **OFF**.

## Indication in the transmitter telemetry display

Select the telemetry display GENERAL.

The following displays will appear, at right the actual cell voltage or the total voltage are alternatively shown. Under BAT1 and SENSOR 1 will appear the actual total voltage, under BAT2 and SENSOR 2 will appear the minimum cell voltage since the battery has been connected.

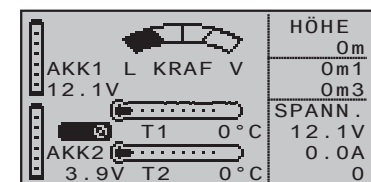
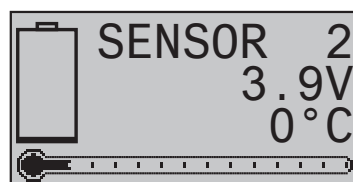
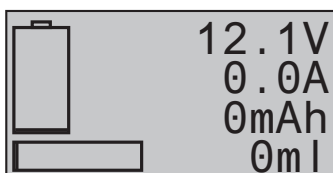
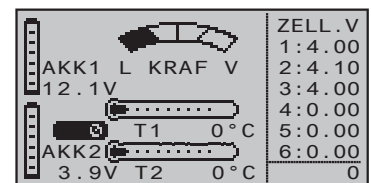
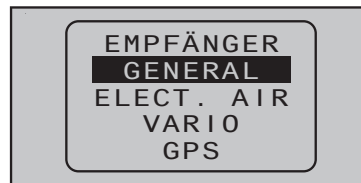
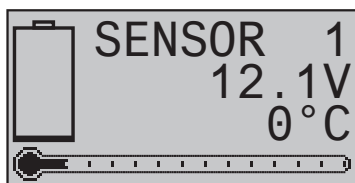

## Meaning of the red LED signals

BEC VOLTAGE	RED LED
4.5V	1x blink
5.0V	2x blinks
5.5V	3x blinks
6.0V	4x blinks
6.5V	5x blinks
7.0V	6x blinks
7.5V	7x blinks
8.0V	LED on

---

## Notes on environmental protection



### Disposal notes

This symbol on the product, user manual or packaging indicates that this product must not be disposed of with other household waste at the end of its life. It must be handed over to the applicable collection point for the recycling of electrical and electronic equipment.

The materials are recyclable as marked. By recycling, material reusing or other forms of scrap usage you are making an important contribution to environmental protection.

Batteries and accumulators must be removed from the device and disposed of at an appropriate collection point. Please inquire if necessary from the local authority for the appropriate disposal site.

---

## Care and maintenance



### Notes on care

The product does not need any maintenance, it works so as it is without any special care. In your own interests protect it from dust, dirt and moisture.

Clean the product only with a dry cloth (do not use detergent!) lightly rub.

---

## Warranty certificate

The Graupner, Henriettenstrasse 96, 73230 Kirchheim/Teck grants from the date of purchase of this product for a period of 24 months. The warranty applies only to the material or operational defects already existing when you purchased the item. Damage due to wear, overloading, incorrect accessories or improper handling are excluded from the guarantee. The legal rights and claims are not affected by this guarantee. Please check exactly defects before a claim or send the product, because we have to ask you to pay shipping costs if the item is free from defects.

The present construction or user manual is for informational purposes only and may be changed without prior notice. The current version can be found on the Internet at [www.graupner.de](http://www.graupner.de) on the relevant product page. In addition, the company **Graupner** has no responsibility or liability for any errors or inaccuracies that may appear in construction or operation manuals.

No liability can be accepted for printing errors.

